



HP Z Workstation series

User Guide

Copyright Information

Seventh Edition: July 2010

Part number: 504629-007

Warranty

Hewlett-Packard Company shall not be liable for technical or editorial errors or omissions contained herein or for incidental or consequential damages in connection with the furnishing, performance, or use of this material. The information in this document is provided "as is" without warranty of any kind, including, but not limited to, the implied warranties of merchantability and fitness for a particular purpose, and is subject to change without notice. The warranties for HP products are set forth in the express limited warranty statements accompanying such products.

Nothing herein should be construed as constituting an additional warranty.

This document contains proprietary information that is protected by copyright. No part of this document may be photocopied, reproduced, or translated to another language without the prior written consent of Hewlett-Packard Company.

Trademark Credits

The HP Invent logo is a trademark of Hewlett-Packard Company in the U.S. and other countries.

Microsoft and Windows are U.S. registered trademarks of Microsoft Corporation.

Intel is a trademark of Intel Corporation in the U.S. and other countries and are used under license.

Acrobat is a trademark of Adobe Systems Incorporated.

ENERGY STAR is a U.S. registered mark of the United States Environmental Protection Agency.

About this guide

This guide provides setup and troubleshooting information for the HP Z Workstation series. It includes these topics:

Guide topics
Locating HP resources on page 1
Workstation components on page 7
Setting up the workstation on page 19
Setting up the operating system on page 31
Restoring the operating system on page 37
Preparing for component installation on page 43
Installing memory on page 47
Installing PCI/PCIe devices on page 53
Installing hard disk drives on page 55
Installing optical disk drives on page 61

 **TIP:** If you do not find what you are looking for in this guide for your HP Z Series workstation, refer to the workstation *Maintenance and Service Guide* on the Web at http://www.hp.com/support/workstation_manuals/, or see <http://www.hp.com/go/workstations> for additional information about your workstation.

Table of contents

1 Locating HP resources	1
Product information	2
Product support	3
Product documentation	4
Product diagnostics	5
Product updates	6
2 Workstation components	7
HP Z400 Workstation components	7
HP Z400 Workstation chassis components	8
HP Z400 Workstation front panel components	9
HP Z400 Workstation rear panel components	10
HP Z600 Workstation components	11
HP Z600 Workstation chassis components	12
HP Z600 Workstation front panel components	13
HP Z600 Workstation rear panel components	14
HP Z800 Workstation components	15
HP Z800 Workstation chassis components	16
HP Z800 Workstation front panel components	17
HP Z800 Workstation rear panel components	18
3 Setting up the workstation	19
Ensuring proper ventilation	19
Setup procedures	20
Converting to desktop configuration (Z400 only)	22
Adding monitors	24
Planning for Additional Monitors	24
Finding supported graphics cards	26
Matching graphics cards to monitor connectors	26
Identifying monitor connection requirements	28
Connecting the monitors	29
Configuring the monitors using Microsoft® operating systems	29
Using a third-party graphics configuration utility	30
Customizing the monitor display (Microsoft operating systems only)	30
Accessibility	30
Security	30
Product recycling	30

4	Setting up the operating system	31
	Setting up the Microsoft operating system	32
	Installing or upgrading device drivers	32
	Transferring files and settings to your Windows workstation	32
	Setting up Red Hat Enterprise Linux	33
	Installing with the HP driver CD	33
	Installing and customizing Red Hat-enabled workstations	34
	Verifying hardware compatibility	34
	Setting up Novell SLED	34
	Updating the workstation	34
	Updating the workstation after first boot	34
	Upgrading the BIOS	34
	Determining current BIOS	35
	Upgrading BIOS	36
	Upgrading device drivers	36
5	Restoring the operating system	37
	Restore methods	37
	Ordering backup software	38
	Restoring Windows 7 or Windows Vista	38
	Ordering the RestorePlus! media	38
	Restoring the operating system	38
	Restoring Windows XP Professional	39
	Creating RestorePlus! media	39
	Creating HP Backup and Recovery (HPBR) media	40
	Restoring the operating system	41
	Using RestorePlus!	41
	Using HPBR	41
	Using the recovery partition	41
	Restoring Novell SLED	41
	Creating restore media	41
6	Preparing for component installation	43
	Disassembly and installation preparation	43
	Preparing the workstation for component installation	43
7	Installing memory	47
	Supported memory configurations	47
	Installing a DIMM	48
	Installing the airflow guide (Z400 only)	50
8	Installing PCI/PCIe devices	53
	Expansion card slot identification	53

Installing an expansion card	53
9 Installing hard disk drives	55
HDD configuration	55
Installing a hard disk drive	56
Installing an HDD in an HP Z400 Workstation	56
Installing an HDD in an HP Z600 or Z800 Workstation	59
10 Installing optical disk drives	61
Installing an ODD in an HP Z400 Workstation	61
Installing an optical drive (mini-tower configuration)	61
Installing an optical drive (desktop configuration)	62
Installing an ODD in an HP Z600 or Z800 Workstation	63
Notice for Blu-ray optical drives	65
Blu-ray movie playback	65
Blu-ray movie playback compatibility and update	65
Index	67

1 Locating HP resources

This section provides information on the following HP resources for your workstation:

Topics

[Product information on page 2](#)

- HP Cool Tools
 - Regulatory information
 - Accessories
 - System board
 - Serial number and Certificate of Authenticity labels
 - Linux
-

[Product support on page 3](#)

- Additional information
 - Technical support
 - Business Support Center
 - IT Resource Center
 - HP Service Center
 - HP Business and IT Services
 - Warranty information
-

[Product documentation on page 4](#)

- User and third-party documentation, and white papers
 - Product notifications
 - QuickSpecs
 - Customer Advisories, Security Bulletins, Notices
-

[Product diagnostics on page 5](#)

- Diagnostics tools
 - Audible beeps and LED code definitions
 - Web-based support tools
-

[Product updates on page 6](#)

- Software, BIOS, and driver updates
 - Operating system reinstallation
 - Operating system
-

Product information

Table 1-1 Product information

Topic	Location
HP Cool Tools	<p>Most HP Microsoft Windows workstations are preloaded with additional software that is not automatically installed during first boot. Additionally, a number of valuable tools on your workstation are preinstalled that may enhance system performance. To access or learn more about these applications, choose one of the following options:</p> <ul style="list-style-type: none">• Click the HP Cool Tools icon on the desktop, or• Open the HP Cool Tools folder by selecting Start > All Programs > HP Cool Tools. <p>To learn more about these applications, click HP Cool Tools—Learn More.</p> <p>To install or launch the applications, click the appropriate application icon.</p>
Regulatory information	<p>Refer to the <i>Safety & Regulatory Information</i> guide for product Class information. You can also refer to the label on the workstation chassis.</p>
Accessories	<p>For complete and current information on supported accessories and components, see http://www.hp.com/go/workstations.</p>
System board	<p>A diagram of the system board is located on the inside of the side access panel. Also, additional information is located in the <i>Maintenance and Service Guide</i> on the Web at http://www.hp.com/support/workstation_manuals/.</p>
Serial number and Certificate of Authenticity (COA) labels (if applicable)	<p>Serial number labels are on the top panel, or on the side of the unit at the rear, depending on the workstation model. The COA label is generally located on the top or side panel near the serial number label. Some workstations have this label on the bottom of the unit.</p>
Linux	<p>For information on running Linux on HP workstations, see http://www.hp.com/linux/.</p>

Product support

Table 1-2 Product support

Topic	Location
Additional information	<p>For online access to technical support information and tools, see http://www.hp.com/go/workstationsupport.</p> <p>Support resources include Web-based troubleshooting tools, technical knowledge databases, driver and patch downloads, online communities, and proactive notification services.</p> <p>The following communication and diagnostic tools are also available:</p> <ul style="list-style-type: none">• Instant Chat• Instant Support• Diagnose Problem <p>Refer to the workstation <i>Maintenance and Service Guide</i> for more information on how to receive support.</p>
Technical support	<p>Before you call technical support, refer to the workstation <i>Maintenance and Service Guide</i> for a listing of information you need to have available before you call.</p> <p>For a listing of all worldwide technical support phone numbers, see http://www.hp.com/support/, select your region, and click Contact HP in the upper-left corner.</p>
Business Support Center (BSC)	<p>For software/driver downloads, warranty information, single-topic documents, user manuals, or service manuals, see http://www.hp.com/go/bizsupport.</p>
IT Resource Center (ITRC)	<p>See http://www.itrc.hp.com/ for a searchable knowledge base for IT professionals.</p>
HP Business and IT Services.	<p>For business and IT information, see http://www.hp.com/hps/.</p>
HP Hardware Support Services	<p>For hardware service information, see http://h20219.www2.hp.com/services/us/en/always-on/hardware-support-supporting-information.html?jumpid=reg_R1002_USEN.</p>
Warranty information	<p>To locate base warranty information, see http://www.hp.com/support/warranty-lookuptool.</p> <p>To locate an existing Care Pack, see http://www.hp.com/go/lookuptool.</p> <p>To extend a standard product warranty, see http://h20219.www2.hp.com/services/us/en/warranty/carepack-overview.html?jumpid=hpr_R1002_USEN. HP Care Pack Services offer upgraded service levels to extend and expand a standard product warranty.</p>

Product documentation

Table 1-3 Product documentation

Topic	Location
HP user documentation, white papers, and third-party documentation	For the latest online documentation, see http://www.hp.com/support/workstation_manuals . These include this User Guide and the <i>Maintenance and Service Guide</i> .
Product notifications	Subscriber's Choice is an HP program that allows you to sign up to receive driver and software alerts, proactive change notifications (PCNs), the HP newsletter, customer advisories, and more. Sign up at http://www.hp.com/go/subscriberschoice/ . Customer advisories and product change notifications are also available on http://www.hp.com/go/bizsupport/ .
Workstation QuickSpecs	The Product Bulletin contains QuickSpecs for HP Workstations. QuickSpecs provide an overall specification review of your product. It includes information about its features including the operating system, power supply, memory, CPU, and many other components of the system. To access the QuickSpecs, see http://www.hp.com/go/productbulletin/ .
Customer Advisories, Security Bulletins, and Notices	To find advisories, bulletins, and notices: <ol style="list-style-type: none">1. See http://www.hp.com/go/workstationsupport.2. Select the desired product.3. From the Resources section, select See more...4. Use the scroll bar to select Customer Advisories, Customer Bulletins, or Customer Notices.

Product diagnostics

Table 1-4 Product diagnostics

Topic	Location
Diagnostics tools	The HP Vision Field Diagnostics utility can be downloaded from the HP Web site. To use this utility, refer to the appropriate section of the workstation <i>Maintenance and Service Guide</i> .
Audible beep and LED code definitions	Refer to the appropriate section of the workstation <i>Maintenance and Service Guide</i> for detailed information about beep and Light Emitting Diode (LED) codes applicable to the workstation.

Product updates

Table 1-5 Product updates

Topic	Location
Software, BIOS, and driver updates	See http://www.hp.com/go/workstationsupport to verify that you have the latest drivers for the workstation. To locate the current workstation BIOS on your Microsoft Windows workstation, select Start>Help and Support>Pick a Task>Use Tools to view...>Tools>My Computer Information>View general system information...
Operating system	For information on operating systems supported on HP workstations, see http://www.hp.com/go/wsos .

2 Workstation components

This chapter describes workstation components and includes these topics:

Topics

[HP Z400 Workstation components on page 7](#)

[HP Z600 Workstation components on page 11](#)

[HP Z800 Workstation components on page 15](#)

HP Z400 Workstation components

This section describes HP Z400 Workstation components, including front and rear panel connectors.

For complete and current information on supported accessories and components for the workstation, see <http://partsurfer.hp.com>.

HP Z400 Workstation chassis components

The following figure shows the chassis components of a typical HP Z400 Workstation. Drive configurations can vary.

Figure 2-1 HP Z400 Workstation chassis components

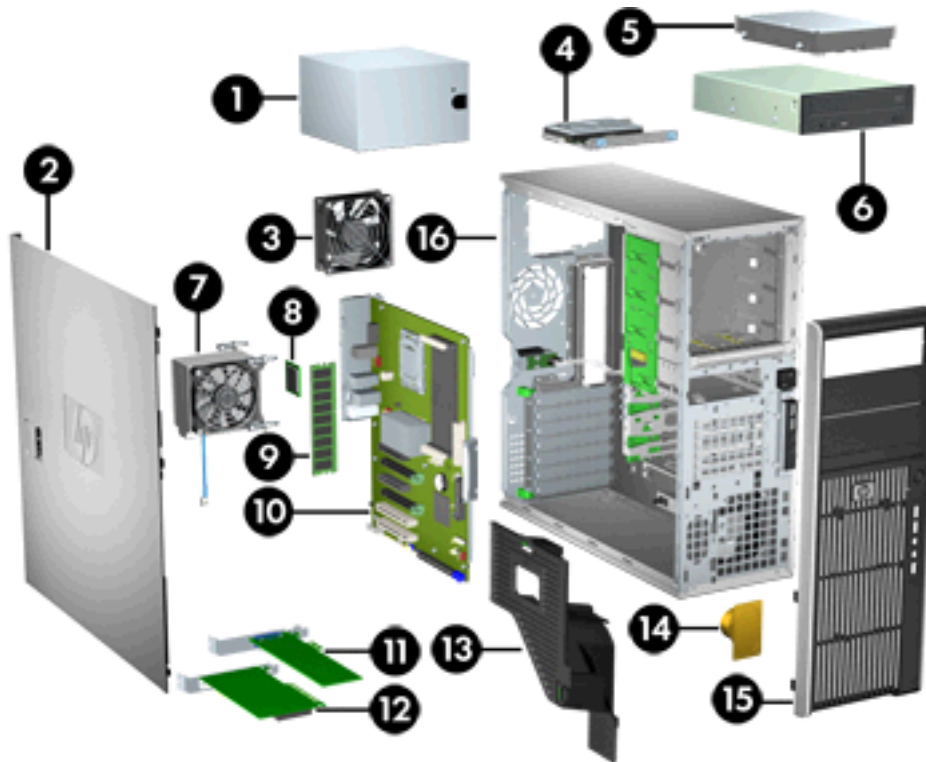

Table 2-1 HP Z400 Workstation chassis components description

Item	Description	Item	Description
1	Power supply	9	Memory module (DIMM)
2	Side access panel	10	System board
3	Rear system fan	11	PCIe card
4	SFF Hard drive	12	PCI card
5	Hard disk drive	13	Airflow guide (for 6-DIMM Z400 product)
6	Optical drive	14	Speaker
7	Processor (CPU) heatsink	15	Front bezel
8	Processor (CPU)	16	Chassis

HP Z400 Workstation front panel components

The following figure shows the front panel of a typical HP Z400 Workstation. Drive configurations can vary.

Figure 2-2 HP Z400 Workstation front panel components

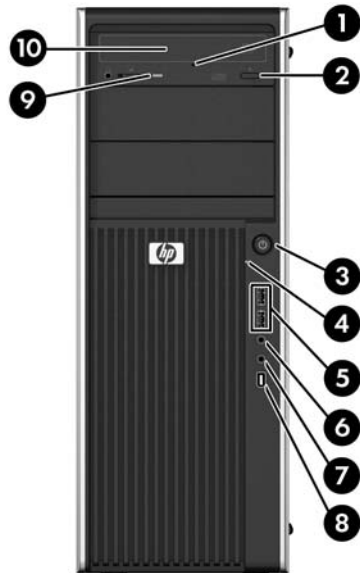







Table 2-2 HP Z400 Workstation front panel components description*

Item	Symbol	Description	Item	Symbol	Description
1		Optical drive manual eject	6		Headphone connector
2		Optical drive eject button	7		Microphone connector
3		Power button	8		1394a connector (optional and plugged unless configured)
4		Hard drive activity light	9		Optical drive activity light
5		USB 2.0 ports (2)	10		Optical drive

* See the *Maintenance and Service Guide* for the workstation for specific front panel component information.

HP Z400 Workstation rear panel components





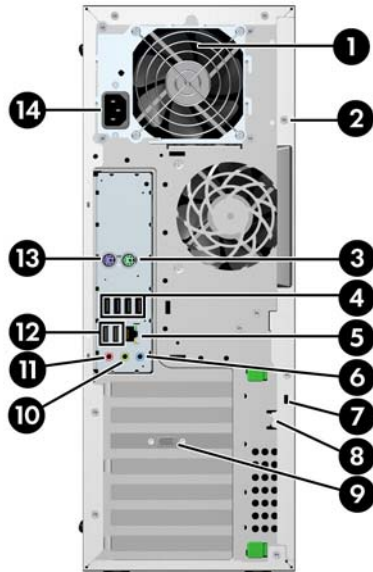



The following figure shows the rear panel of a typical HP Z400 Workstation.

Figure 2-3 HP Z400 Workstation rear panel components



NOTE: The rear panel connectors are labeled with industry-standard icons and colors to assist in connecting peripheral devices.

Table 2-3 HP Z400 Workstation rear panel components description

Item	Symbol	Description	Item	Symbol	Description
1		Power supply Built-In Self Test (BIST) LED	8		Padlock loop
2		Universal chassis clamp opening	9		Graphics card connector
3		PS/2 mouse connector (green)	10		Audio line-out connector (green)
4		USB 2.0 ports (4)	11		Microphone connector (pink)
5		RJ-45 network connector	12		USB 2.0 ports (2)
6		Audio line-in connector (blue)	13		PS/2 keyboard connector (purple)
7		Cable lock slot	14		Power cord connector

HP Z600 Workstation components

This section describes HP Z600 Workstation components, including front and rear panel components.

For complete and current information on supported accessories and components for the workstation, see <http://partsurfer.hp.com>.

HP Z600 Workstation chassis components

The following image shows a typical HP Z600 Workstation. Drive configurations can vary.

Figure 2-4 HP Z600 Workstation components

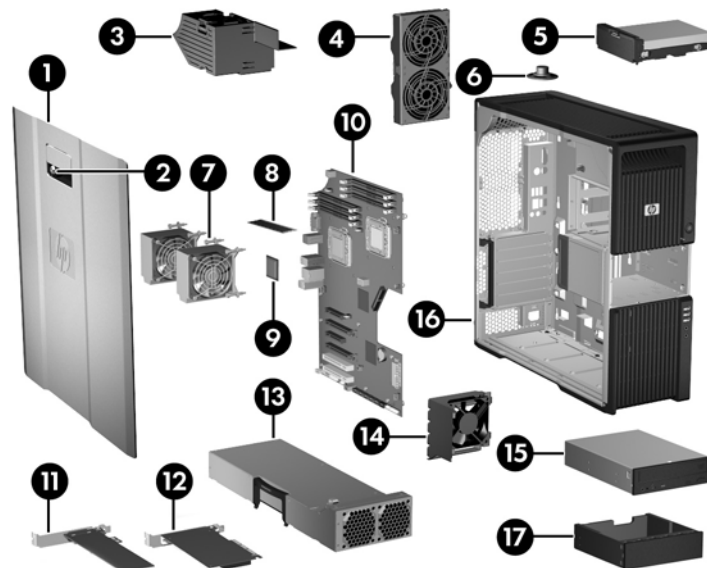

Table 2-4 HP Z600 Workstation component descriptions

Item	Description	Item	Description
1	Side access panel	10	System board
2	Side access panel key lock	11	PCIe card
3	Memory duct/fan housing	12	PCI card
4	Rear system fans	13	Power supply
5	Hard drive	14	Card guide and front fan
6	Speaker	15	Optical drive
7	Processor (CPU) heatsinks	16	Chassis
8	Memory module (DIMM)	17	Optical bay fillers (optional or other devices)
9	Processor (CPU)		

HP Z600 Workstation front panel components

The following figure shows the front panel of a typical HP Z600 Workstation.

Figure 2-5 HP Z600 Workstation front panel

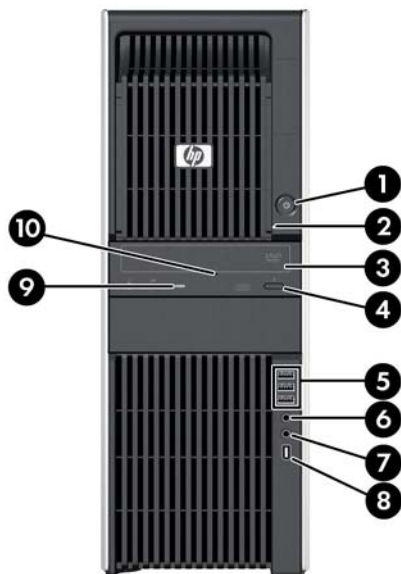







Table 2-5 HP Z600 Workstation front panel connectors*

Item	Symbol	Description	Item	Symbol	Description
1		Power button	6		Headphone connector
2		Hard drive activity light	7		Microphone connector
3		Optical drive	8		IEEE-1394a connector (standard with RDIMM system board)
4		Optical drive eject button	9		Optical drive activity light
5		USB 2.0 ports (3)	10		Optical drive manual eject

* See the *Maintenance and Service Guide* for the workstation for specific front panel connector information.

HP Z600 Workstation rear panel components





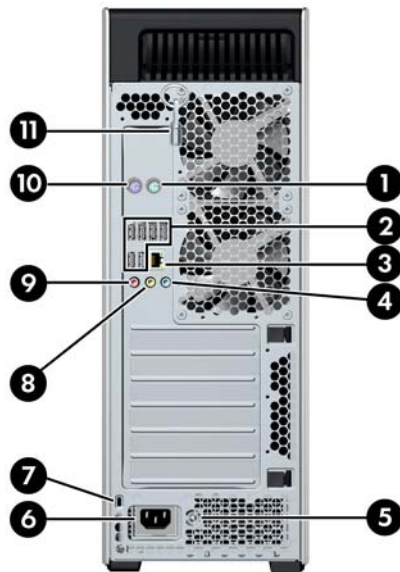

The following figure shows the rear panel of a typical HP Z600 Workstation.

Figure 2-6 HP Z600 Workstation rear panel



NOTE: The rear panel connectors are labeled with industry-standard icons and colors to assist in connecting peripheral devices.

Table 2-6 HP Z600 Workstation rear panel connectors

Item	Symbol	Description	Item	Symbol	Description
1		PS/2 mouse connector (green)	7		Cable lock slot
2		USB 2.0 ports (6)	8		Audio line-out connector (green)
3		RJ-45 network connector	9		Microphone connector (pink)
4		Audio line-in connector (blue)	10		PS/2 keyboard connector (purple)
5		Power supply Built-In Self Test (BIST) LED	11		Side access panel key
6		Power cord connector			

HP Z800 Workstation components

This section describes HP Z800 Workstation components, including front and rear panel components.

For complete and current information on supported accessories and components, see <http://partsurfer.hp.com>.

HP Z800 Workstation chassis components

The following image shows a typical HP Z800 Workstation. Drive configurations can vary.

Figure 2-7 HP Z800 Workstation components



Table 2-7 HP Z800 Workstation component descriptions

Item	Description	Item	Description
1	Airflow guide	11	Memory module (DIMM)
2	Side access panel	12	Processor (CPU)
3	Side access panel key lock	13	System board
4	Memory fans	14	Expansion card support
5	Rear system fans	15	PCIe card
6	Power supply	16	PCI card
7	Speaker	17	Hard disk drive
8	Optical drive	18	System board retainer/front fan holder
9	Optical bay fillers (optional or other devices)	19	Front system fan*
10	Processor (CPU) heatsinks	20	Chassis

*Two fans installed in 1110W power supply version.

HP Z800 Workstation front panel components

The following illustration shows the front panel components of a typical HP Z800 Workstation. Drive configurations can vary.

Figure 2-8 HP Z800 Workstation front panel

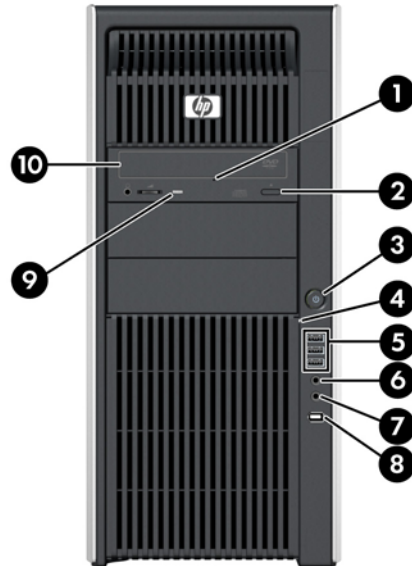







Table 2-8 HP Z800 Workstation front panel connectors*

Item	Symbol	Description	Item	Symbol	Description
1		Optical drive manual eject	6		Headphone connector
2		Optical drive eject button	7		Microphone connector
3		Power button	8		IEEE-1394a connector
4		Hard drive activity light	9		Optical drive activity light
5		USB 2.0 ports (3)	10		Optical Drive

* Refer to the *Maintenance and Service Guide* for the workstation for specific front panel connector information.

HP Z800 Workstation rear panel components





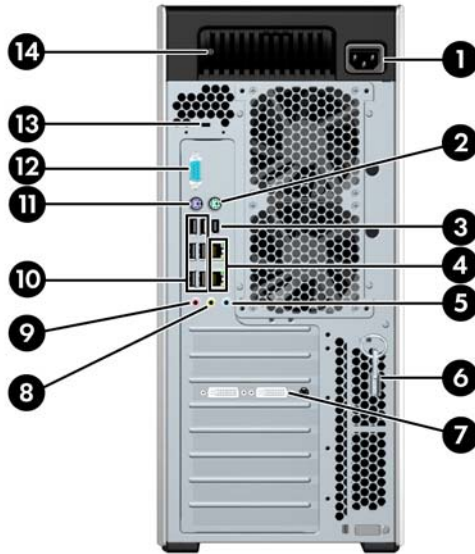



The following illustration shows the rear panel of a typical HP Z800 Workstation. Drive configurations can vary.

Figure 2-9 HP Z800 Workstation rear panel



NOTE: The rear panel connectors are labeled with industry-standard icons and colors to assist in connecting peripheral devices.

Table 2-9 HP Z800 Workstation rear panel connectors

Item	Symbol	Description	Item	Symbol	Description
1		Power cord connector	8		Audio line-out connector (green)
2		PS/2 mouse connector (green)	9		Microphone connector (pink)
3		IEEE-1394 connector	10		USB 2.0 ports (6)
4		RJ-45 network connectors (2)	11		PS/2 keyboard connector (purple)
5		Audio line-in connector (blue)	12		Serial connector
6		Side access panel key	13		Cable lock slot
7		Graphics connector	14		Power supply Built-In Self Test (BIST) LED

3 Setting up the workstation

This chapter describes how to set up the workstation, and includes these topics:

Topics
Ensuring proper ventilation on page 19
Setup procedures on page 20
Converting to desktop configuration (Z400 only) on page 22
Adding monitors on page 24
Accessibility on page 30
Security on page 30
Product recycling on page 30

Ensuring proper ventilation

Proper ventilation for the system is important for workstation operation. Follow these guidelines to ensure adequate ventilation:

- Operate the workstation on a sturdy, level surface.
- Place the workstation in an area with adequate ventilation. Provide at least 15.24 CM (6 inches) of clearance at the front and back of the workstation as shown in the following figure.

Your workstation might look different than the one shown.

Figure 3-1 Proper workstation ventilation



- Ensure that the ambient air temperature surrounding the workstation falls within the published limit.

 **NOTE:** The ambient upper limit of 35 C is only good up to 1524 M (5000 FT) elevation. There is a 1 C per 304.8 M (1000 FT) derating above 1524 M (5000 FT). So, at 3,048 M (10,000 FT), the upper ambient air temperature limit is 30 C.

- For cabinet installation, ensure adequate cabinet ventilation and ensure that the ambient temperature within the cabinet does not exceed published limits.
- Never restrict the incoming or outgoing airflow of the workstation by blocking any vents or air intakes as shown in the following figure.

Figure 3-2 Proper workstation placement

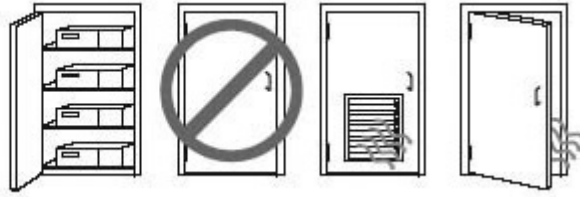

Setup procedures

 **WARNING!** To reduce the risk of electric shock or damage to your equipment:

- Do not disable the power cord grounding plug. The grounding plug is an important safety feature.
 - Plug the power cord in a grounded (earthed) outlet that is easily accessible.
-

To set up the workstation:

1. After unpacking your HP Workstation, find workspace with the proper ventilation to set up the system.
2. Connect the mouse and keyboard to the workstation.

For connector location information, see the rear panel connector section for the workstation in this document.

3. Connect the power cord:

Figure 3-3 Connecting the power cord



⚠ WARNING! To reduce the risk of electric shock or damage to your equipment, observe these practices:

- Plug the power cord into an AC outlet that is easily accessible.
- Disconnect power from the computer by unplugging the power cord from the AC outlet (not by unplugging the power cord from the computer).
- If provided with a three-pin attachment plug on your power cord, plug the cord into a grounded (earthed) three-pin outlet. Do not disable the power cord grounding pin, for example, by attaching a two-pin adapter. The grounding pin is an important safety feature.

📝 NOTE: After setting up the workstation hardware, connect other peripheral components (such as a printer) according to the instructions included with the device.

Converting to desktop configuration (Z400 only)

This workstation can be operated in the mini-tower or the desktop configuration. Follow these steps to convert to desktop configuration operation:

 **NOTE:** See the workstation *Maintenance and Service Guide* for installation details for the following steps.

1. Prepare the workstation for component installation (see [Preparing the workstation for component installation on page 43](#)).
2. Remove the front bezel from the workstation.
3. Press gently on the edges of the optical drive bay filler panel, and remove it from the front bezel as shown in the following figure.

Figure 3-4 Removing the ODD bay filler panel

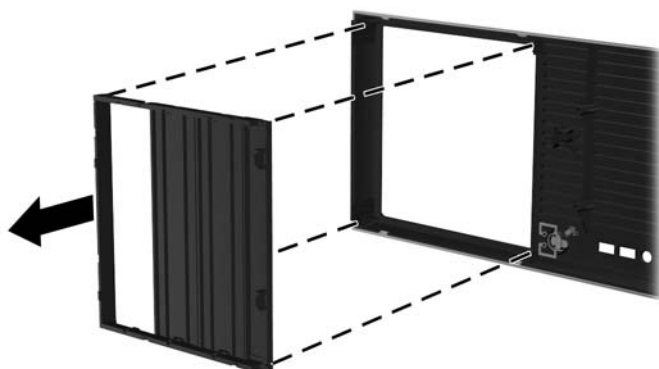

4. Rotate the filler panel 90 degrees to a horizontal position.
5. Align the slots in the filler panel frame with the tabs in the front bezel. Press the optical drive filler panel back into the front bezel until it snaps into place as shown in the following figure.

Figure 3-5 Installing the ODD bay filler panel

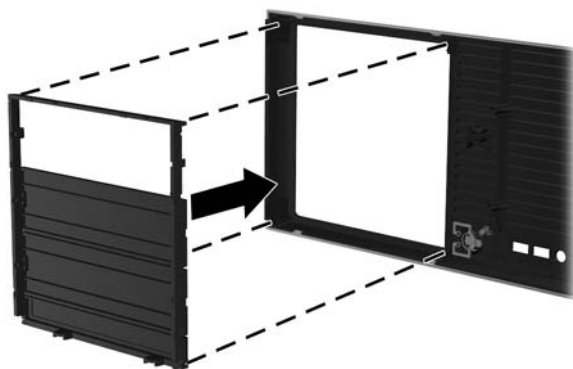

6. On the back of the front bezel, squeeze the HP logo mounting tabs (1) and press the logo outward (2) as shown in the following figure.

Figure 3-6 Rotating the HP logo

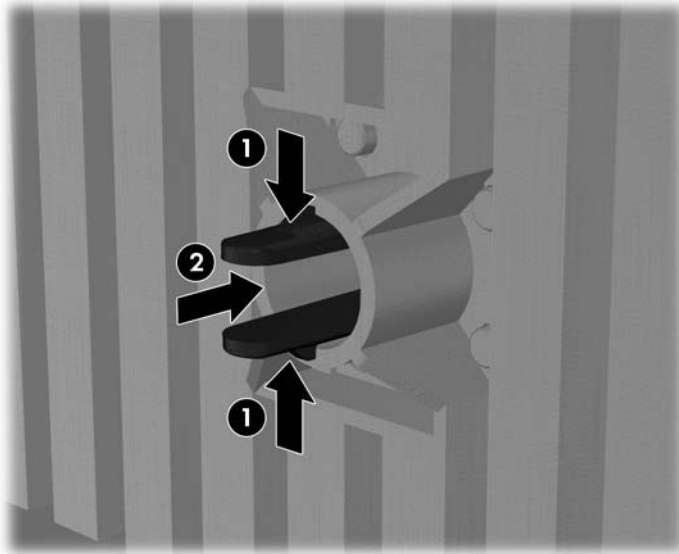

Rotate the HP logo 90 degrees counterclockwise, and then release the logo and press it back into place in the front bezel.

7. Remove the EMI filler panels and remove the optical disk drive from the chassis.
8. Rotate the EMI filler panels and the optical drive 90 degrees as shown in the figure below, and then reinstall them (see [Installing an optical drive \(desktop configuration\) on page 62](#)).

Figure 3-7 Reinstalling the optical drive



9. Replace the front bezel and the side access panel when finished.

Adding monitors

This section describes how to connect monitors to the workstation.

Planning for Additional Monitors

All graphics cards provided with HP Z series computers support two simultaneous display monitors (see [Connecting the monitors on page 29](#)). Other cards that support more than two monitors are available. The process for adding monitors depends on your graphics card(s) and the type and number of monitors you want to add.

Use this process to plan for adding more monitors:

1. Assess your monitor needs:

- Determine how many monitors you require.
- Determine the kind of graphics performance that you want.
- Note the type of graphics connector used by each monitor. HP provides graphics cards with DisplayPort (DP) and DVI interfaces, but you can use adapters and third-party cards to interface to other graphics formats, including DVI-I, HDMI, or VGA.

 **TIP:** Some adapters for older legacy hardware may cost more than others. You may want to compare the cost of acquiring adapters versus the cost of getting a newer monitor that doesn't need adapters.

2. Determine if you need additional graphics cards:

- Consult the graphics card documentation to determine how many monitors you can connect to the card.
 - You may need to acquire adapters to match the card output to the monitor connector. (See [Matching graphics cards to monitor connectors on page 26](#).)

 **NOTE:** Monitors with resolutions above 1920 x 1200 pixels at 60Hz require a graphics card with either Dual Link DVI or Display Port output. To get native resolution with DVI, however, you must use a DL-DVI cable, not standard DVI-I or DVI-D cables.

- If necessary, plan to acquire a new graphics card to drive additional monitors.

 **NOTE:** HP computers do not support all graphics cards. Make sure a new graphics card is supported before purchasing it. To find out how to list supported graphics cards and get other information, see [Finding supported graphics cards on page 26](#).

- The maximum number of monitors that a graphics card supports depends on the card. Most cards provide outputs for two monitors. Some provide four outputs.

 **NOTE:** Many graphics cards provide more than two monitor outputs but limit you to using only two at a time. Consult the graphics card documentation or look up information on the card according to the procedure in [Finding supported graphics cards on page 26](#).

 **NOTE:** Some graphics cards support multiple monitors by multiplexing the monitor signal across multiple outputs. This may reduce graphics performance. Consult the graphics card documentation or look up information on the card according to the procedure in [Finding supported graphics cards on page 26](#).

- Make sure the card outputs match the input required by the monitors. (See [Identifying monitor connection requirements on page 28](#).)
- The different models of Z-series computers have different limits on the mechanical size, data speed, and power available for additional graphics cards. In addition, the usual practical limit for graphics cards is two per computer. Refer to the [Expansion card slot identification on page 53](#) section to make sure a new graphics card will work for your computer.

3. If you find that you must add a new graphics card or cards:

- a. Determine which HP-supported graphics card will best fit your needs in terms of number of monitors, compatibility with the monitors you plan to use, and performance. To find out more about supported graphics cards, see [Finding supported graphics cards on page 26](#).
- b. Make sure you have the correct drivers for the graphics card.
- c. Install the first graphics card as per the instructions in this manual. (See [Installing PCI/PCIe devices on page 53](#).)
- d. Configure the monitor in Windows (see [Configuring the monitors using Microsoft® operating systems on page 29](#)) or with a third-party configuration tool (see [Using a third-party graphics configuration utility on page 30](#)).

 **TIP:** To simplify troubleshooting of possible problems, enable the monitors one at a time, i.e., enable the first monitor and then make sure the card, connections, and monitor all work properly before enabling the next monitor.





Finding supported graphics cards

To find out more information about graphics cards supported for your computer:

1. Go to: <http://www.hp.com/go/workstationsupport>
2. Click on the link for your computer in the list of Personal Workstations (for example, **HP Z400 Workstation**). This opens an information page for your computer.
3. Under the heading, **Hot topics for this product**, click on **Product Overview**. This displays an overview page for your computer.
4. Scroll down to the Graphics section to view a list of graphics cards supported for your computer.
5. (Optional) To display more detailed info on the supported graphics cards:
 - a. Click on the link **Links to Product Quickspecs** or scroll down to the heading, **Links to Product Quickspecs**,
 - b. Click on a link to display Quickspecs according to your region and whether you want to view the information as a PDF file or in HTML format. For example, click on **Click here to access the HP Z400 Workstation North America Quickspecs in pdf format** if you own a Z400 in North America and want to view the file in PDF. This displays the Quickspecs information for your computer.
 - c. Click on the link for **Technical Specifications-Graphics**. This displays expanded technical information for the graphics cards supported for your computer. This information includes how many monitors the card supports, connectors, power consumption, drivers, and other details.

Matching graphics cards to monitor connectors

The following table describes monitor configuration scenarios.

Graphics card interface connector	Monitor connector		
	VGA	DVI	DISPLAYPORT (DP)
DISPLAYPORT 	DisplayPort to VGA adapter (sold separately)	DP to DVI adapter	No adapter required
DVI 	DVI to VGA adapter	No adapter required	N/A
VGA (ON LEFT)/DVI 	No adapter required	No adapter required	N/A
DMS-59* 	DMS-59 to VGA (sold separately)	DMS-59 to DVI	N/A

* This interface is a dual-monitor graphics interface card that supports two VGA or two DVI monitors.

 **NOTE:** HP graphics cards include monitor cable adapters unless otherwise indicated.

 **NOTE:** VGA graphics cards have the lowest performance while DisplayPort cards have the highest.

Identifying monitor connection requirements

The following are various scenarios for connecting monitors. (See [Matching graphics cards to monitor connectors on page 26](#) for more information about the different graphic cards):

- **Graphics card with DisplayPort output** — If the workstation has a graphics card with four DisplayPort output receptacles, you can connect a monitor to each receptacle. Use the proper adapters if required.
- **Graphics card with DVI output** — If the workstation has a PCIe graphics card with two DVI output receptacles, you can connect a monitor to each DVI receptacle. Use the proper adapters if required.

 **NOTE:** Some HP computers have only one DVI port. However, such computers will always have a second graphics output option (Display Port or VGA). Note also that many graphics cards provide more than two monitor outputs but limit you to using only two at a time. Consult the graphics card documentation or look up information on the card according to the procedure in [Finding supported graphics cards on page 26](#).

 **NOTE:** If you need to identify port number 1 on a system with two DVI connections, it provides the primary display, which is where the BIOS POST screen appears after a system boot. (Usually, this is the lower of the two outputs. Only one card is used during BIOS POST, although you can change this in the BIOS settings.)

- **Graphics card with SVGA and DVI-D output** — If the workstation does not have a PCIe graphics card, but has one or more SVGA *and/or* a DVI-D output receptacles located on the rear panel of the workstation chassis, you can connect a monitor to each output.
- **Graphics card with DMS-59 output** — If the workstation has a PCIe graphics card with a DMS-59 output receptacle, use the appropriate adapter to connect your monitors.

Adapters are available to connect the DMS-59 output to two DVI or two VGA monitors.

Connecting the monitors

 **NOTE:** HP-supported graphics card typically support at least two monitors, as shown in this section; some supported cards support more monitors. Refer to the graphics card documentation for details.

1. Connect the monitor cable adapters (1) (if required) to the workstation, then connect the appropriate monitor cables to the adapters (2) or directly to the graphics card, as shown in the following figure.

Figure 3-8 Connecting the cables to the workstation



2. Connect the other ends of the graphics cables to the monitors as shown below.

Figure 3-9 Connecting cables to the monitors

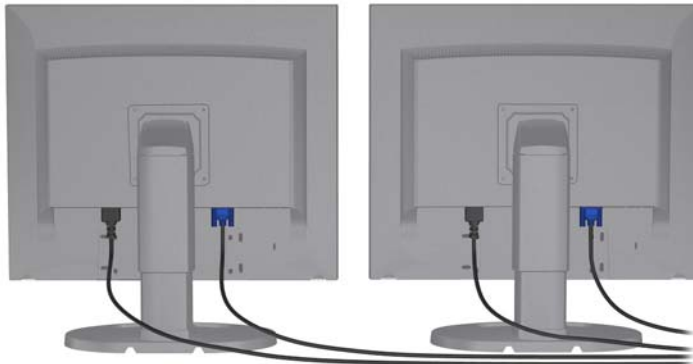

3. Connect one end of the monitor power cord to the monitor and the other end to a grounded power outlet.

Configuring the monitors using Microsoft® operating systems

Refer to Microsoft Help information or the Microsoft Web site for details about monitor configuration procedures.

Using a third-party graphics configuration utility

Third-party graphics cards may include a monitor configuration utility. Upon installation, this utility is integrated into Windows. You can select the utility and use it to configure multiple monitors with your workstation.

Refer to your graphics card documentation for instructions on using the monitor configuration utility.

 **NOTE:** Some third-party configuration utilities require that you enable the monitors in Windows before using the configuration tool. Refer to your graphics card documentation for more information.

 **NOTE:** Monitor configuration utilities are also often available on the HP support Web site.

Refer to the *Linux User Guide* for instructions about using Linux to configure monitors with your workstation.

Customizing the monitor display (Microsoft operating systems only)

You can manually select or change the monitor model, refresh rates, screen resolution, color settings, font sizes, and power management settings.

To change display settings, right-click on the Windows Desktop, then click **Properties** in Microsoft® Windows® XP Professional or **Personalize** in Microsoft® Windows Vista™ Business.

For more information about customizing your monitor display, see these resources:

- Online documentation provided with the graphics controller utility
- Documentation included with your monitor

Accessibility

HP is committed to developing products, services, and information that is easier to access for all customers, including customers with disabilities and age-related limitations. HP products with Microsoft® Windows Vista™ Business and Microsoft® Windows® XP Professional preinstalled are designed for accessibility, and these products are tested with industry-leading Assistive Technology products. See <http://www.hp.com/accessibility> for more information.

Security

Some HP workstations have a lock on the side access panel. The key for this lock is shipped attached to the back panel of the workstation chassis.

The workstation includes several security features to reduce the risk of theft and to warn of chassis intrusion. Refer to the *Maintenance and Service Guide* for information about additional hardware and software security features available for your system.

Product recycling

HP encourages customers to recycle used electronic hardware, HP original print cartridges, and rechargeable batteries.

For information about recycling HP components or products, see <http://www.hp.com/go/recycle>.

4 Setting up the operating system

This chapter provides setup and update information for the workstation operating system. It includes these topics:

Topics

[Setting up the Microsoft operating system on page 32](#)

[Setting up Red Hat Enterprise Linux on page 33](#)

[Setting up Novell SLED on page 34](#)

[Updating the workstation on page 34](#)

This chapter also includes information on how to determine that you have the latest BIOS, drivers, and software updates installed on the workstation.

-
- △ **CAUTION:** Do not add optional hardware or third-party devices to the HP workstation until the operating system is successfully installed. Adding hardware might cause errors and prevent the operating system from installing correctly.
-

Setting up the Microsoft operating system

 **NOTE:** If you ordered a downgrade from Windows 7 or Windows Vista to Windows XP Professional operating system, your system will be preinstalled with Windows XP Professional operating system. With this configuration, you will receive recovery media for the Windows 7 or Windows Vista operating system only. In case you need to restore or recover the Windows XP Professional operating system in the future, it is important that you create recovery media disks for Windows XP Professional operating system after first boot.

When you first apply power to the workstation, the operating system is installed. This process takes approximately 5 to 10 minutes. Carefully follow the instructions on the screen to complete the installation.

 **CAUTION:** After installation has started, do *not* turn off the workstation until the process is complete. Turning off the workstation during installation can damage the installation and operation of the software.

For complete operating system installation and configuration instructions, see the operating system documentation that was provided with the workstation. Additional information is available in the online help tool after you successfully install the operating system.

Installing or upgrading device drivers

To install hardware devices after the operating system is installed, you must install the appropriate device drivers before you install the devices. Follow the installation instructions that came with the device. In addition, for optimum performance, your operating system must have the most recent updates, patches, and software fixes. For additional driver and software update information, refer to [Upgrading device drivers on page 36](#).

Transferring files and settings to your Windows workstation

The Microsoft Windows operating system offers data migration tools that helps you choose and transfer files and data from a Windows computer to your Windows 7, Windows Vista, or Windows XP Professional operating system workstation.

For instructions on how to use these tools, see the documents at <http://www.microsoft.com>.

Setting up Red Hat Enterprise Linux

HP offers an HP Installer Kit for Linux (HPIKL) to supplement Red Hat box sets and help HP Linux customers customize their system image. The HPIKL contains the HP driver CD and device drivers to successfully setup up the Red Hat Enterprise Linux (RHEL) operating system, The HP Installer Kit for Linux CDs are currently available for download at http://www.hp.com/support/workstation_swdrivers.

Installing with the HP driver CD

To install the HP driver CD, see “Installing with the HP Installer Kit for Linux” in the *HP Workstations for Linux* manual at http://www.hp.com/support/workstation_manuals.

Installing and customizing Red Hat-enabled workstations

Linux-enabled workstations require the HP Installer Kit and the purchase of a Red Hat Enterprise Linux box set. The Installer kit includes the HP CDs necessary to complete the installation of all versions of the Red Hat Enterprise Linux box set that have been qualified to work on an HP workstation.

To use the drivers in the HP Installer kit for Linux other than RHEL, you must manually extract the drivers from the HP Driver CD and install them. HP does not test the installation of these drivers on other Linux distributions nor does HP support this operation.

Verifying hardware compatibility

To see which Linux versions have been qualified to work on HP Workstations visit http://www.hp.com/support/linux_hardware_matrix.

Setting up Novell SLED

To set up the SUSE Linux Enterprise Desktop (SLED) on systems preloaded with the operating system:

1. Boot the workstation.
2. Start the Installation Settings and enter the password, network, graphics, time, keyboard settings, and Novell Customer Center Configuration for the workstation.



NOTE: During Installation Settings after the first time after booting the system the Novell subscription can be activated from the Novell Customer Center Configuration screen. Visit the full Novell Customer Center documentation at <http://www.novell.com/documentation/ncc/>.

Updating the workstation

HP is constantly working on improving your total workstation experience. To ensure that the workstation leverages the latest enhancements, HP recommends that you install the latest BIOS, driver, and software updates on a regular basis.

Updating the workstation after first boot

After successfully booting the workstation for the first time, you should follow these guidelines to ensure that the workstation is up-to-date:

- Ensure that you have the latest system BIOS loaded. See [Upgrading the BIOS on page 34](#) for instructions.
- Ensure that you have the latest drivers for your system. See [Upgrading device drivers on page 36](#) for instructions.
- Become familiar with your available HP resources.
- Consider a subscription to Driver Alerts at <http://www.hp.com/go/subscriberschoice>.

Upgrading the BIOS

For optimum performance, determine the BIOS revision on the workstation, and upgrade it if necessary.

Determining current BIOS

To determine the current BIOS of the workstation during system power up:

1. Wait for F10=setup to appear on the lower right corner of the screen.
2. Press **F10** to enter the F10 Setup utility.

The F10 Setup utility displays the workstation BIOS version under **File > System Information**.

3. Note the workstation BIOS version so that you can compare it with the BIOS versions that appear on the HP website.

Upgrading BIOS

To find and download the latest available BIOS, which includes the latest enhancements:

1. Go to <http://www.hp.com/go/workstationsupport>.
2. Select **Download Drivers and Software** from the left menu column under Tasks.
3. Follow the instructions to locate the latest BIOS available for the workstation.
4. If the BIOS on the Web site is the same as the version on your system, no further action is required.
5. If the BIOS on the Web site is a version later than the one on your system, download the appropriate version for the workstation. Follow the instructions in the release notes to complete the installation.

Upgrading device drivers

If you install a peripheral device (such as a printer, display adapter, or network adapter), confirm you have the latest device drivers loaded. If you purchased your device through HP, visit the HP Web site to download the latest drivers for your device. These drivers have been tested to ensure the best compatibility between your device and your HP workstation.

If you did not purchase your device from HP, HP recommends visiting the HP Web site first to see if your device and its drivers have been tested for HP workstation compatibility. If no driver is available, visit the device manufacturer's Web site to download the latest drivers.

To upgrade device drivers:

1. Go to <http://www.hp.com/go/workstationsupport>.
2. Select **Download Drivers and Software** from the left menu column under Tasks.
3. Follow the instructions to find the latest drivers available for the workstation.

If a needed driver is not found, see the Web site of the manufacturer of the peripheral device.

5 Restoring the operating system

This chapter describes how to restore the Windows or Linux operating system. It includes these topics:

Topics
Restore methods on page 37
Ordering backup software on page 38
Restoring Windows 7 or Windows Vista on page 38
Restoring Windows XP Professional on page 39
Restoring Novell SLED on page 41

Restore methods

The Windows 7 or Windows Business Vista operating system can be reinstalled using the HP RestorePlus! process. The Windows XP Professional operating system can be reinstalled using the RestorePlus! process or the HP Backup and Recovery Manager.

- RestorePlus!

The RestorePlus! process reinstalls the Windows operating system and device drivers (for devices included with the system) to a near-factory state. The process does not back up or recover data on the hard drive. Some application software might not be restored using this process and must be installed from the appropriate application CD.

- HP Backup and Recovery Manager (HPBR) Recovery Point

The HP Backup and Recovery Manager application can be used to capture and restore the contents of the system partition. It captures a snapshot of the system partition and stores it in a Recovery Point. Everything on the system partition at the time the recovery point was made is saved.

 **NOTE:** HP Backup and Restore is only supported on the HP xw6600 and xw8600 Workstations.

The Recovery Point is saved to the hard drive and can be burned to media for safekeeping.

 **CAUTION:** These methods restore the operating system, but not data. Data must be backed up regularly to avoid loss.

Ordering backup software

If you cannot create system recovery CDs or DVDs, you can order a recovery disk set from the HP support center. To obtain the support center telephone number for your region see <http://www.hp.com/support/contactHP>.

Restoring Windows 7 or Windows Vista

This section describes how to restore Windows 7 or Windows Vista.

Ordering the RestorePlus! media

If you ordered restore media with your workstation, the media is included with your workstation components.

If you did not order restore media, call HP Support and request a RestorePlus! media kit. For worldwide technical support phone numbers, see <http://www.hp.com/support>.

Restoring the operating system

 **NOTE:** Windows 7 and Windows Vista provide a backup and restore application as well. To learn more about this application, see the Microsoft Web site.

 **CAUTION:** Before you restore the operating system, back up your data.

When you run RestorePlus! from media, the process deletes all information on the primary hard drive, including all partitions.

To restore Windows 7 or Windows Vista:

1. Boot from the RestorePlus! DVD to start the RestorePlus! process. You must start from the RestorePlus! DVD to install device drivers and settings.
2. Follow the prompts to restore your operating system.

Some application software might not be restored using this process. If software is not restored, install it from the appropriate application DVD.

Restoring Windows XP Professional

This section describes how to restore the Windows XP Professional operating system.

 **NOTE:** The workstation must have a CD or DVD writer installed to create the media set.

Creating RestorePlus! media

The RestorePlus! kit can be created using the files contained on the hard drive. To create the restore media:

1. Boot the workstation.
2. During boot up, an HP Backup and Recovery Manager screen is displayed prompting you to create Recovery CDs or DVDs. Select **Now**.
3. An Initial Recovery Point (IRP) of the system is captured. This is a snapshot of the system hard drive. The capture can take more than 10 minutes.
4. After the IRP is created, you can create a set of backup CDs or DVDs.

To create a RestorePlus! media set including the Windows XP operating system CD, select **RestorePlus! > Microsoft Windows XP operating system > Supplemental media**.

 **NOTE:** Depending on the options, there might be additional DVDs you can create.

5. Follow the prompts to create RestorePlus!, operating system, and HPBR media.

If you are unable to create CD/DVDs on your workstation, call HP Support and request a RestorePlus! media kit. For worldwide technical support phone numbers, see <http://www.hp.com/support>.

Creating HP Backup and Recovery (HPBR) media

 **NOTE:** HPBR is only supported on Windows XP systems. For details, refer to the documentation on the Supplemental Software - *HP Backup and Recovery* CD included with the workstation. The documentation can be accessed during installation.

The Initial Recovery Point can be burned to optical media and used to recover a system. This section describes making the media.

 **NOTE:** The workstation must have a CD or DVD writer to create the media set.

To create HPBR recovery media:

1. The Initial Recovery Point was captured when the RestorePlus! media set was created previously.

If the IRP was not created, start the HP Backup and Recovery Manager and create recovery points using the Expert mode. Follow the HPBR online documentation for instructions.

2. Burn the IRP to media from HPBR.

Select **HPBR Start > All Programs > HP Backup & Recovery > HP Backup and Recovery Manager**.

3. Select **Next** at the first screen.

Select **Create recovery CDs or DVDs to recover the system**, and then select **Next**.

4. Choose **Next** to display a list of available CD image and the recovery points.

5. Check the box next to Initial Recovery Point, and then select **Next**.

6. Follow the instructions to create the media.

Restoring the operating system

△ **CAUTION:** Before you restore the operating system, back up your data.

When you run RestorePlus! from media, the process deletes all information on the primary hard drive, including all partitions. If you run RestorePlus! from the recovery partition, only the root (C:) partition is affected.

Using RestorePlus!

To restore with RestorePlus!:

1. Boot the workstation from the RestorePlus! DVD. You must start from the RestorePlus! DVD for device drivers and settings to be installed.
2. Follow the prompts to restore the operating system.

Some application software might not be restored using this process. If software is not restored, install it from the appropriate application DVD.

Using HPBR

To restore with the HPBR Initial Recovery Point media:

1. Boot the workstation from the Initial Recovery Point media.
2. Follow the prompts to restore the system to the state when the IRP was created.

Using the recovery partition

A system that shipped with Windows XP includes a recovery partition. You can boot the system from that recovery partition.

From the recovery partition you can perform a system restore using the HPBR Initial Recovery Point, if it was created. If it was not, you can use a RestorePlus! install.

To restore using the recovery partition:

1. Boot the workstation.
2. When prompted on the boot screen to enter the Recovery Manager, press **F11**.

💡 **TIP:** The opportunity to press F11 during the boot process is small. It comes about the time the F10 prompt appears.

📝 **NOTE:** To ensure that the recovery processes reinstall on the correct hard drive, do not disconnect the target drive during the recovery process.

3. Follow the prompts to restore the system to factory-like condition.

Restoring Novell SLED

The SLED restore media is required to restore the Linux operating system.

Creating restore media

THE SUSE Linux Enterprise Desktop preload includes a SUSE ISO icon on the desktop. You can click this icon to go to the `/iso` directory. The `/iso` directory contains all iso images used to preload your workstation. To recover or restore the original image, follow the instructions in the readme file in the `/iso` directory to copy the ISO image file onto CDs.

 **NOTE:** Make copies of the ISO recovery images on CD as backup files in case your workstation experiences a hard drive failure.

6 Preparing for component installation

To facilitate the installation of components, several steps can be taken to prepare the workstation. This section describes how to prepare your workstation for component installation.

Disassembly and installation preparation

Use the following table to determine the order of workstation disassembly required before installing components. (Your workstation components may be different than those listed.)

Table 6-1 Workstation component installation

To install...	Remove...	Then remove...	Then remove...	Then remove...	Then remove...
Memory	Chassis locks*	Side access panel	Air flow guide (Z800, and optional on Z400)	Memory fan or airflow guide (if required)	
Expansion card (PCI/PCIe)	Chassis locks	Side access panel	Air flow guide (Z800)	Expansion card support	Expansion card slot cover
Hard drive	Chassis locks	Side access panel			
Optical drive	Chassis locks	Side access panel	Front bezel (Z400 only)	Air flow guide (Z800 and optional on Z400)	Expansion card support (Z800)



* See the workstation *Maintenance and Service Guide* for chassis lock locations and operation instructions.

Preparing the workstation for component installation

To prepare the workstation:

 **NOTE:** The workstation contains green, plastic touch points at locations where you must manipulate a button or lever. Green touch points on some components indicate tool-less removal of those components.

1. Disconnect power from the system.
2. Unlock the side access panel or remove any chassis locks.
3. Remove the side access panel as shown in the following illustrations.

Z400	Z600	Z800
<p>Pull up on the handle (1), slide the cover 1/2-inch toward the rear of the system (2), then rotate the cover off the chassis (3).</p> 	<p>Lift the side access panel handle (1), and remove the side access panel (2).</p> 	<p>Lift the side access panel handle (1), and remove the side access panel (2).</p> 

4. Remove the expansion card clamp or support as shown in the following illustrations, as applicable.

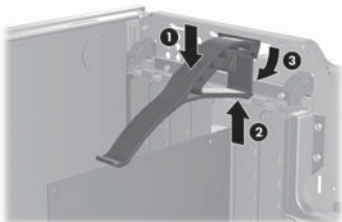
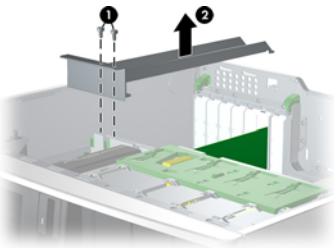
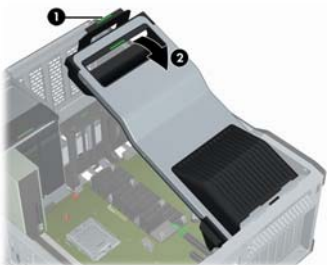
Z400	
<p>Some Z400s use a hold down clamp; grasp the top of the clamp (1), squeeze the release handles on the side of the clamp until the bottom of the clamp releases from the clamp rail (2), then swing the clamp out from the back panel (3).</p> 	<p>Some Z400s have a card support. Remove the card support screws (1), and then lift the expansion card support from the chassis (2).</p> 
Z800	
<p>Lift the release tab (1), and then lift the expansion card support handle (2) to remove the expansion card support.</p> 	

5. Remove the memory and system fans as shown in the following illustrations, if applicable.

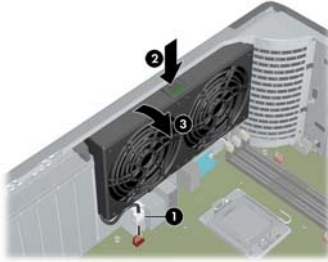
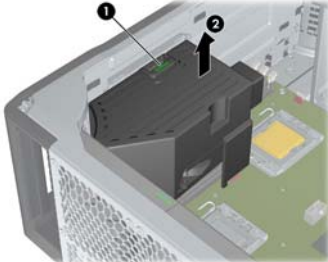
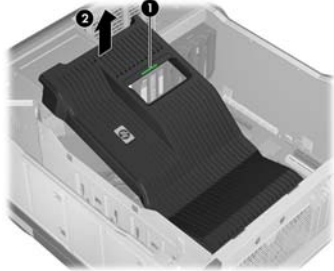
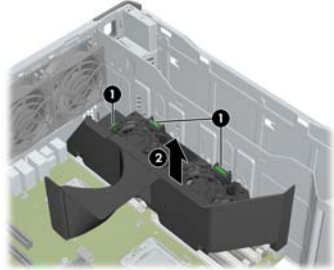
Z400 (optional)	Z600	Z800
<p data-bbox="336 233 697 333">Press the airflow guide release latches as shown in the following figure, and guide the airflow guide out of the chassis.</p> 	<p data-bbox="716 233 1062 363">Disconnect the fan cable from the system board (1), press the release tab at the green touch point (2), and then rotate the rear system fan assembly from the chassis (3).</p>  <p data-bbox="716 695 1043 800">Press the release tab at the green touch point (1), and then lift the memory fan assembly from the chassis (2).</p> 	<p data-bbox="1096 233 1442 308">Remove the Z800 air flow guide as shown in the following illustration, if applicable.</p>  <p data-bbox="1096 642 1439 747">Press the release tabs at the green touch points (1), and then lift the memory fan assembly from the chassis (2).</p> 

6. Raise the expansion card retention clamp and remove the expansion card slot cover as shown in the following illustrations, if applicable.

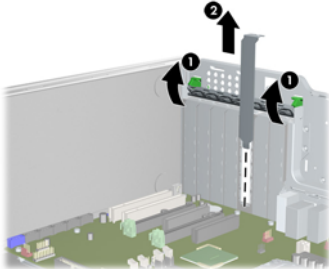
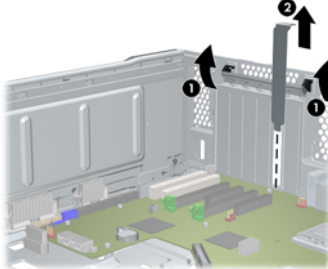
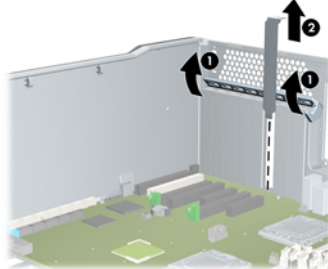
Z400	Z600	Z800
<p data-bbox="336 1287 687 1367">Open the card retention clamp at the green touch points (1), and then lift the slot cover from the chassis (2).</p> 	<p data-bbox="716 1287 1051 1367">Open the card retention clamp (1), and then lift the slot cover from the chassis (2).</p> 	<p data-bbox="1096 1287 1431 1367">Open the card retention clamp (1), and then lift the slot cover from the chassis (2).</p> 

7. Remove the HP Z400 Workstation front bezel as shown in the following illustration, if applicable. Lift the release tabs (1), and then rotate the front bezel off the chassis (2).

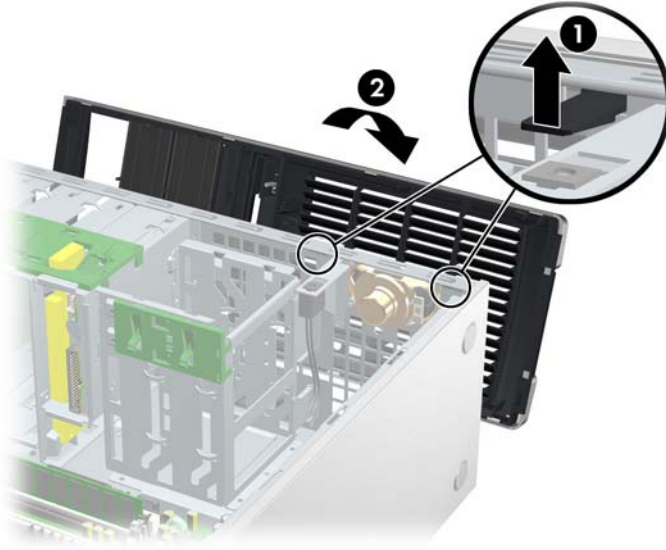

7 Installing memory

This section describes how to add memory to your workstation.

Supported memory configurations



Refer to the quick specs at <http://www.hp.com/go/productbulletin> for specific DIMM compatibility information for HP workstations.

 **NOTE:**

- HP Z Series Workstations support only ECC DIMM Memory.
- Do not intermix Unbuffered DIMM Memory with Registered DIMM Memory. The system will not boot and will produce a memory error.
- For maximum performance, install the same number of DIMMs per CPU. Install them in pairs of the same size if your workstation has two CPUs.

The following table describes the memory configurations supported by the HP Z Workstation series.

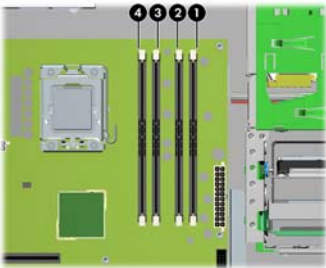
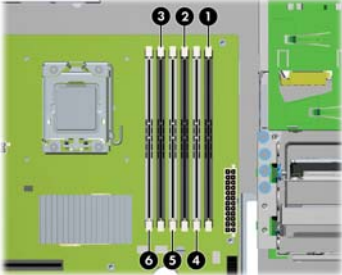
Z400	Z600	Z800
Installation guidelines Install only HP-approved, unbuffered, DDR3 DIMMs.	Installation guidelines Install only HP-approved DDR3 DIMMs. Use all unbuffered DIMMs or all registered DIMMs.	Installation guidelines Install only HP-approved DDR3 DIMMs. Use all unbuffered DIMMs or all registered DIMMs.

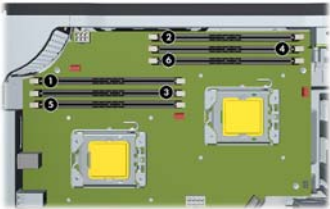
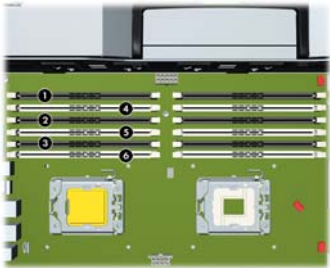
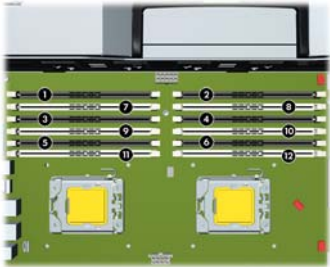
Z400	Z600	Z800
<p>4-DIMM supported configurations</p> <ul style="list-style-type: none"> • Four DIMM slots • Memory configuration from 1 GB to 16 GB <p>6-DIMM supported configurations</p> <ul style="list-style-type: none"> • Six DIMM slots • Memory configurations from 1GB to 24GB 	<p>Supported configurations</p> <ul style="list-style-type: none"> • Six DIMM slots • Unbuffered DIMM memory configuration from 1 GB to 24 GB • Registered DIMM memory configuration from 4 GB to 48 GB 	<p>Supported configurations</p> <ul style="list-style-type: none"> • Twelve DIMM slots • Memory configuration from 1 GB to 192 GB <p>NOTE: Memory configurations greater than 96 GB require the 1110W power supply.</p>
<p>DIMM installation order</p> <p><i>4-DIMM slots</i></p>  <p><i>6-DIMM slots</i></p> 	<p>DIMM installation order</p> <p><i>Single processor:</i></p>  <p><i>Dual processor:</i></p> 	<p>DIMM installation order</p> <p><i>Single processor:</i></p>  <p><i>Dual processor:</i></p> 

Installing a DIMM

To install a DIMM:

1. Follow the procedures described in [Preparing for component installation on page 43](#) to prepare the workstation for component installation.

2. Push gently outward on the DIMM socket levers as shown in the following illustration. (The example shows a HP Z600 Workstation.)

Figure 7-1 Opening DIMM socket levers

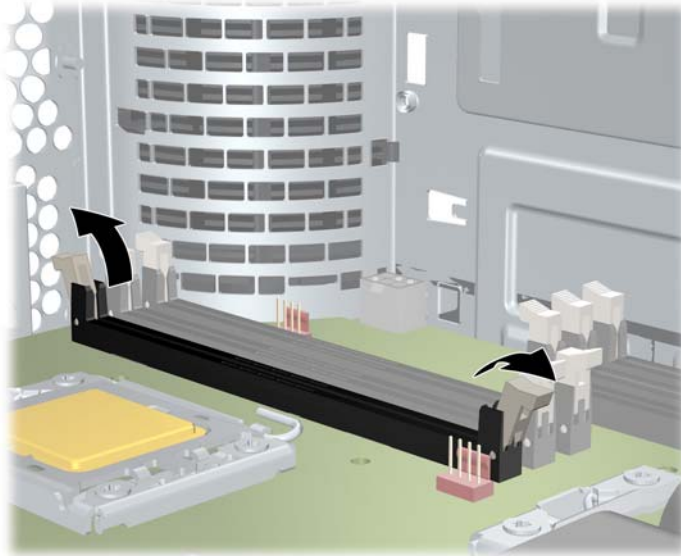

3. Align the DIMM connector key with the DIMM socket key, and then seat the DIMM firmly in the socket (1) as shown in the following illustration.

△ **CAUTION:** DIMMs and their sockets are keyed for proper installation. To prevent socket or DIMM damage, align these guides properly when installing DIMMs.

Figure 7-2 Seating the DIMM

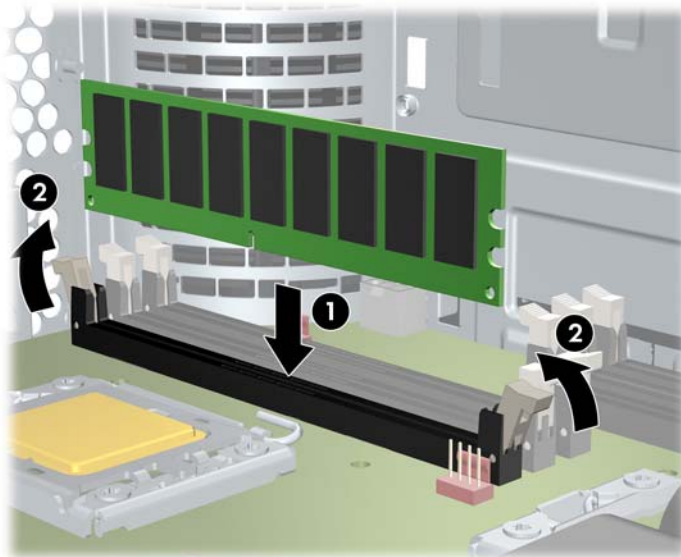

4. Secure the socket levers (2).
5. Replace all components that were removed in preparation for component installation.

Installing the airflow guide (Z400 only)

1. Follow the procedures described in [Preparing for component installation on page 43](#) to prepare the workstation for component installation.
2. Press the power cables, including P1, down toward the system board between the DIMM slots and the internal bay, as shown in the following figure.

Figure 7-3 Positioning the chassis cables

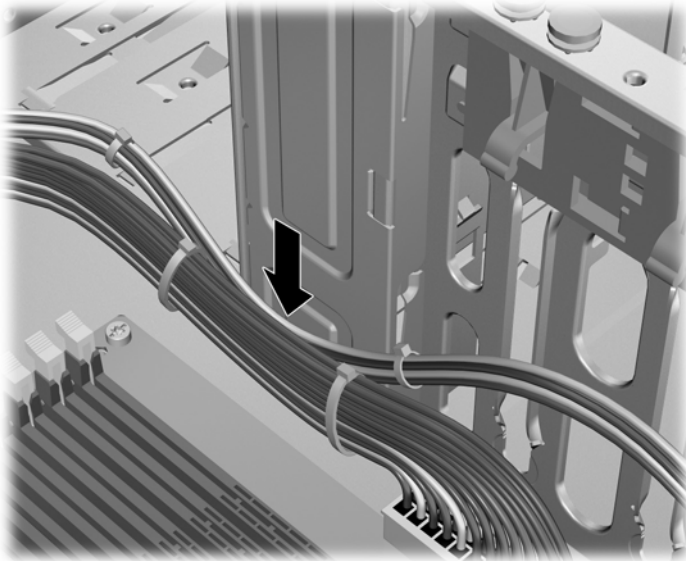

3. Set the airflow guide into the chassis.
 - a. Place the edge of the airflow guide (1) between DIMM socket #6 and the CPU heatsink.

Figure 7-4 Installing the airflow guide

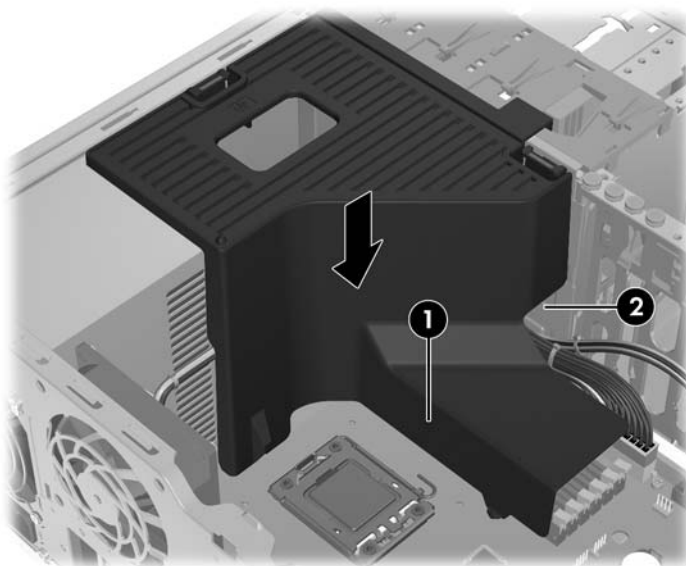

- b. Route the power and data cables through the opening next to the internal bay (2).

4. Route the CPU power cable (P3) through the opening next to the power supply as shown in the following figure.

Figure 7-5 Routing the CPU power cable

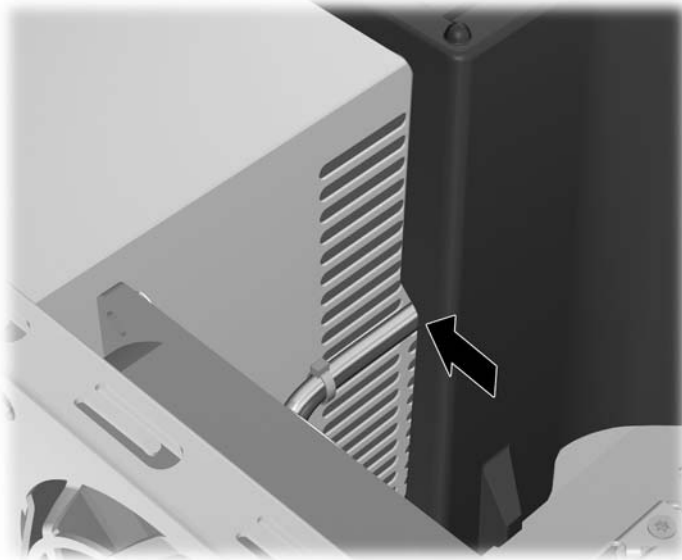

5. Secure the airflow guide in the chassis.
 - a. Insert the tab on the airflow guide into the slot next to the yellow ODD release lever (1), and then press down as shown in the following figure.

Figure 7-6 Securing the airflow guide

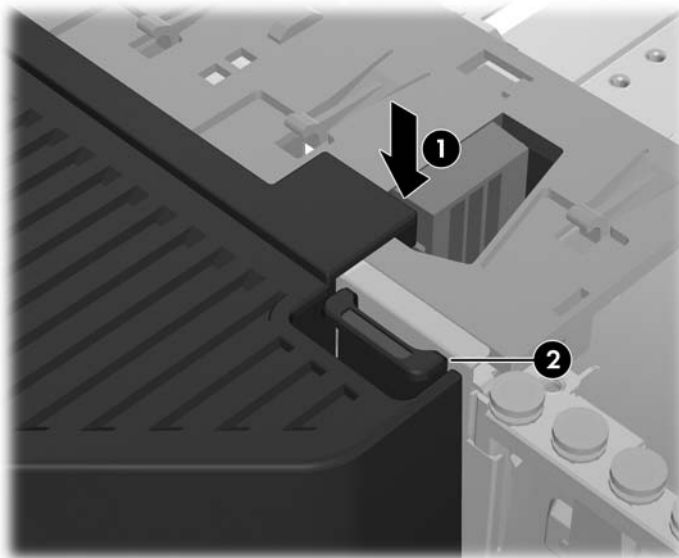

- b. Ensure that the airflow guide secures even with the end of the FDD bay, and that the latch (2) engages with the slot in the internal bay cover.

- c. Ensure that the latch on the top of the airflow guide snaps under the edge of the chassis frame as shown in the following figure.

Figure 7-7 Securing the airflow guide latch

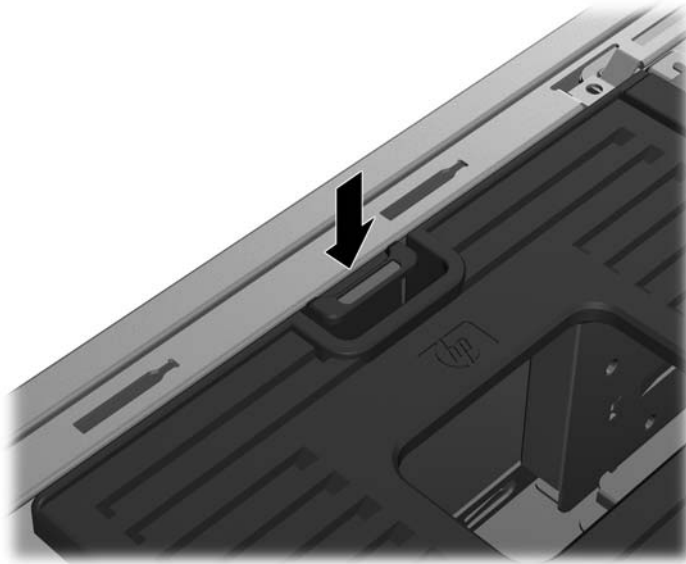

6. Replace all components that were removed in preparation for component installation.

8 Installing PCI/PCIe devices

This section describes how to install a PCI or PCIe card in the workstation. To increase the performance and functionality of your system, PCI/PCIe devices such as graphics cards or audio cards can be installed in the expansion card slots on the workstation.

Expansion card slot identification

The following table describes the expansion card slots in the HP Z Workstation series.

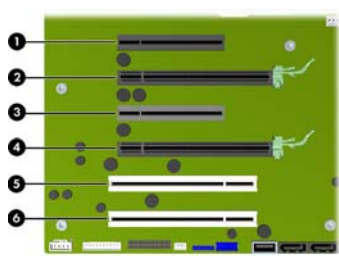
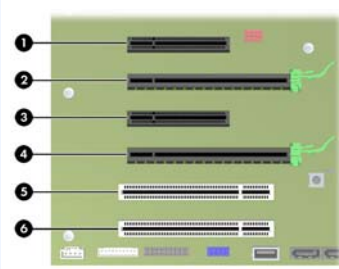
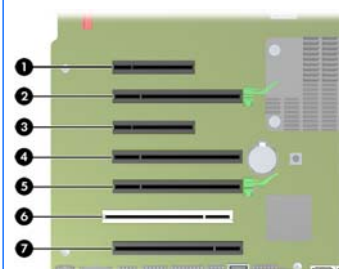
Z400	Z600	Z800
 <p>Diagram showing the expansion slots on the Z400 workstation motherboard. Slots are numbered 1 through 6. Slot 1 is a PCIe2 x8 (4) 25W slot. Slots 2 and 4 are PCIe2 x16 75W slots. Slots 3 and 5 are PCI 32/33 25W slots. Slot 6 is a PCI 32/33 25W slot.</p>	 <p>Diagram showing the expansion slots on the Z600 workstation motherboard. Slots are numbered 1 through 6. Slot 1 is a PCIe2 x8(4) 25W slot. Slots 2 and 4 are PCIe2 x16 75W slots. Slots 3 and 5 are PCI 32/33 25W slots. Slot 6 is a PCI 32/33 25W slot.</p>	 <p>Diagram showing the expansion slots on the Z800 workstation motherboard. Slots are numbered 1 through 7. Slot 1 is a PCIe2 x8(4) 25W slot. Slot 2 is a PCIe2 x16 75W slot. Slot 3 is a PCIe x8(4) 25W slot. Slot 4 is a PCIe2 x16(8) 25W slot. Slot 5 is a PCIe2 x16 75W slot. Slot 6 is a PCI 32/33 25W slot. Slot 7 is a PCIe x16(8) 25W slot.</p>
<p>Slot description</p> <ul style="list-style-type: none"> 1-PCIe2 - x8 (4) 25W 2-PCIe2 - x16 75W 3-PCIe - x8 (4) 25W 4-PCIe2 - x16 75W 5-PCI 32/33 25W 6-PCI 32/33 25W 	<p>Slot description</p> <ul style="list-style-type: none"> 1-PCIe2 - x8(4) 25W 2-PCIe2 - x16 75W 3-PCIe - x8(4) 25W 4-PCIe2 - x16 75W 5-PCI 32/33 25W 6-PCI 32/33 25W 	<p>Slot description</p> <ul style="list-style-type: none"> 1-PCIe2 x8(4) 25W 2-PCIe2 x16 75W 3-PCIe x8(4) 25W 4-PCIe2 x16(8) 25W 5-PCIe2 x16 75W 6-PCI 32/33 25W 7-PCIe x16(8) 25W

△ **CAUTION:** To prevent damage, the overall power consumption of the system (including I/O cards, CPU, and memory) must not exceed the maximum rating of the system power supply.

📖 **NOTE:** The x1, x4, x8, and x16 designators describe the mechanical length of the slot. The number in parentheses lists the number of electrical PCIe lanes routed to the expansion slot. For example, x16(8) means that the expansion slot is mechanically a x16 length connector, with eight PCIe lanes connected.

Installing an expansion card

📖 **NOTE:** The following procedure describes how to install an expansion card in a typical HP Z-series workstation. Your workstation may look different.

To install a PCI or PCIe expansion card:

1. Follow the procedures described in [Preparing for component installation on page 43](#) to prepare the workstation for component installation.
2. Align the card keyway with the slot key, and then firmly seat the card in the slot as shown in the following illustration (1).

Figure 8-1 Installing an expansion card

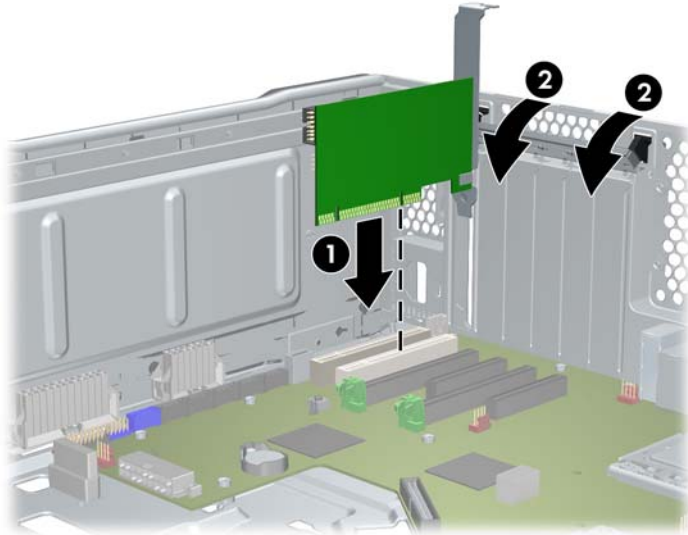

3. Close the retention clamp by rotating it downward (2) as shown in the illustration above.

 **NOTE:** For the Z800, close the PCI retention clamp to make sure all cards are seated. The retention clamp is secured by the PCI Card Support.

4. Connect all necessary power and interface cables to the card (follow instructions that came with the expansion card).
5. Replace all components removed in preparation for component installation.



9 Installing hard disk drives

This section describes how to install a hard disk drive (HDD) in the workstation.

HDD configuration

The following table contains hard disk drive installation configuration information.

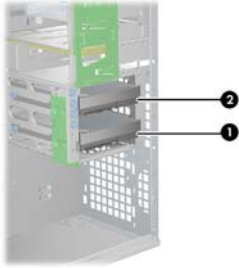
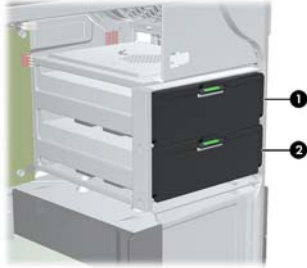
Z400	Z600	Z800
<p>HDD bays are designed to permit easy installation. Data cables are pre-connected in the workstation based on the factory configuration delivered.</p> <p>The workstation typically ships with an HDD, but additional drives can be added to expand data storage:</p> <ul style="list-style-type: none">• Refer to the service label on the side access panel of your workstation to determine the location of the SAS and SATA ports.• Additional HDDs must be added in a specific sequence, depending on the type of workstation.• Once installed, the HDDs are assigned drive letters, with C:\ being the typical boot disk. Drive letters are assigned using the Computer Setup (F10) Utility.• With additional HDDs installed, the workstation boot sequence can be modified so that the workstation boots from one of the additional drives. Boot sequence is specified using the Computer Setup (F10) Utility. <p>With additional HDDs installed, you have hard disk space for additional programs, data files, and backup.</p> <p>Refer to the workstation <i>Maintenance and Service Guide</i> at http://www.hp.com/support/workstation_manuals to learn how many HDDs the workstation can accommodate, drive installation order, and boot sequencing procedures.</p>		

Z400	Z600	Z800
<p>Drive and cable configuration</p> <p>The HDD bays are not labeled on the chassis.</p> <p>The cables plug into the system board connectors in the following manner:</p> <ul style="list-style-type: none"> SATA HDD cables are plugged into SATA ports, starting at SATA port zero. SAS HDD cables do not plug into system board connectors, but into a separate SAS controller card. 	<p>Drive and cable configuration</p> <p>The HDD bays are labeled 0 (top bay) and 1.</p> <p>The bays provide two data cables. They are labeled HDD BAY 0, and HDD BAY 1.</p> <p>The cables plug into the system board connectors in the following manner:</p> <ul style="list-style-type: none"> SATA HDD cables are plugged into SATA ports, starting at SATA port zero. If the last HDD plugged in is SATA, cables from empty HDD bays are plugged into SATA ports. <p>NOTE: This would be the first HDD (empty second bay). Also, if your HDD is different than the existing drive, you may have to disconnect/reconnect the data cable to the correct controller.</p>	<p>Drive and cable configuration</p> <p>The HDD bays are labeled 0 (top bay), 1, 2, and 3.</p> <p>The bays provide four data cables. They are labeled HDD BAY 0, HDD BAY 1, HDD BAY 2, and HDD BAY 3.</p> <p>The cables plug into the system board connectors in the following manner:</p> <ul style="list-style-type: none"> SATA HDD cables are plugged into SATA ports, starting at SATA port zero. If the last HDD plugged in is SATA, cables from empty HDD bays are plugged into SATA ports. <p>NOTE: This would be the first HDD (empty second bay). Also, if your HDD is different than the existing drive, you may have to disconnect/reconnect the data cable to the correct controller.</p> <ul style="list-style-type: none"> SAS HDD cables are plugged into SAS ports, starting at SAS port zero. If the last HDD plugged in is SAS, cables from empty HDD bays are plugged into SAS ports.
<p>HDD installation order</p> 	<p>HDD installation order</p> 	<p>HDD installation order</p> 

Installing a hard disk drive

This section describes how to install a hard disk drive in the workstation.

Installing an HDD in an HP Z400 Workstation

To install an HDD:

- Follow the procedures described in [Preparing for component installation on page 43](#) to prepare the workstation for component installation.
- Select a drive bay in which to install the hard disk drive.

3. Locate the four isolation grommet screws on the chassis.

Figure 9-1 Location of the isolation grommet screws

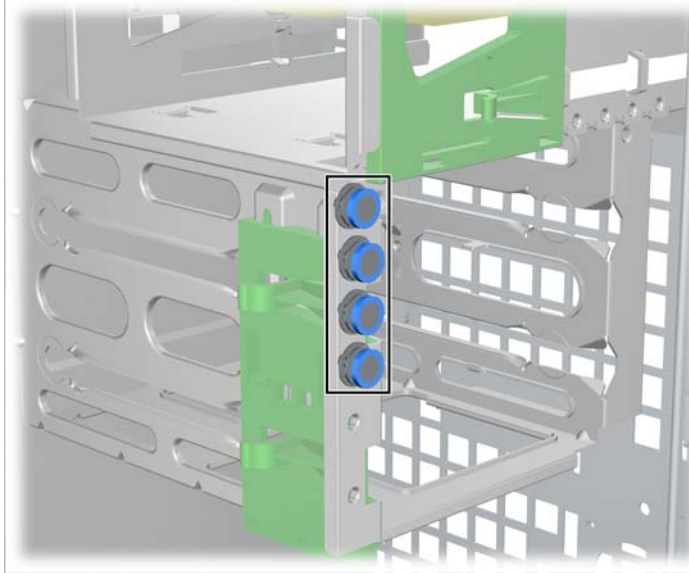

4. Install the four isolation grommet screws as shown in the following figure.

Figure 9-2 Installing the grommet screws



5. If installing a SAS drive, attach a SAS-to-SATA cable adapter to the connector on the SAS hard drive as shown in the following figure.

 **NOTE:** SAS Drives require a separate SAS Controller plug-in card.

Figure 9-3 Attaching the cable adapter



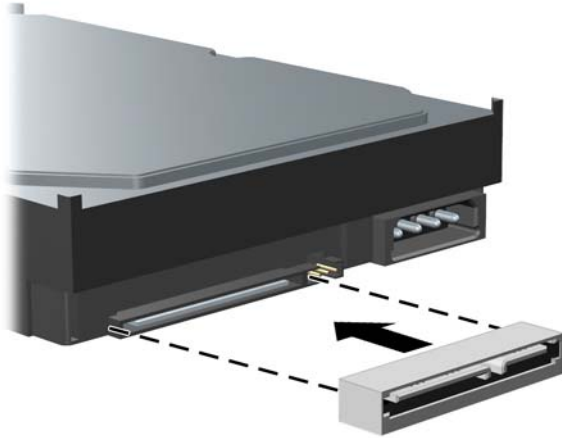
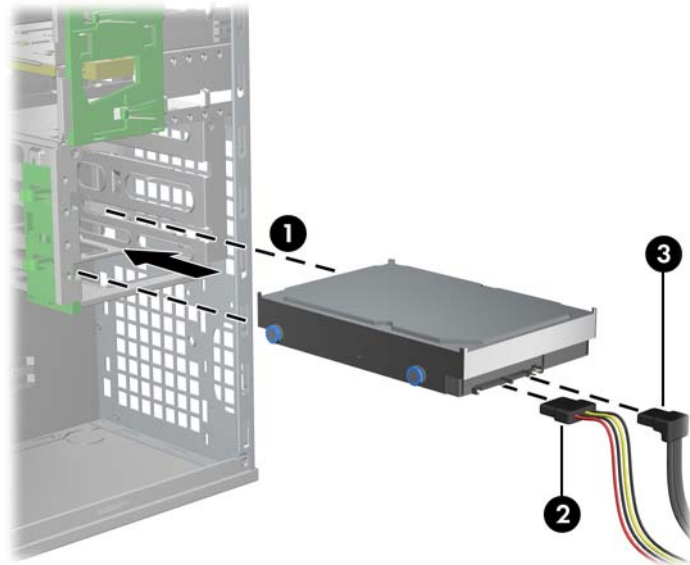

6. Push the hard disk drive into the selected bay until it snaps into place (1) as shown in the following figure.

Figure 9-4 Installing the HDD drive



7. Attach a power cable (2) to the drive, and attach a data cable (3) from the SATA port or SAS controller to the hard disk drive.

 **CAUTION:** To avoid crushing or pinching the data cable when you replace the access panel, use a data cable with a right-angle connector when you install a HDD in bay 1 or bay 2.

 **NOTE:** For SATA and SAS HDDs, connect data cables to lower-numbered drive connectors first on the system board (for SATA HDDs) or SAS controller card (for SAS HDDs). To identify hard disk drive connectors, refer to the workstation service label on the side access panel.

8. Replace all components that were removed in preparation for component installation.

Installing an HDD in an HP Z600 or Z800 Workstation

To install an HDD:

1. Follow the procedures described in [Preparing for component installation on page 43](#) to prepare the workstation for component installation.
2. Select a drive bay in which to install the hard disk drive.
3. Set the hard disk drive in the carrier at an angle. Carefully separate the lower hard drive carrier rails (1), and then lower the drive between them as shown in the following illustration.

Release the rails to lock the drive in place.

Figure 9-5 Installing the drive in the carrier



4. Carefully separate the upper hard disk drive carrier rails (2), and then rotate the drive upright (3) as shown above.

Release the rails to lock the drive in place.

5. Rotate the hard disk drive handle down into its fully open position. Carefully push the drive into its slot until it comes to a hard stop (1) as shown in the following illustration. (An HP Z600 Workstation is shown for example.)

When the hard disk drive is installed, rotate the drive handle up until it snaps into place, fully securing the drive (2).

 **NOTE:** The hard disk drive carrier handle is used as a lever to properly seat the connectors and to securely retain the drive. If the handle is closed prematurely, the proper connection is not made and the drive is not retained properly.

Figure 9-6 Installing the HDD in the chassis



6. When installing a SAS hard disk drive in a Z600 Workstation, a SAS Controller card must be installed. Move the drive data cable from the system board SATA connector to the SAS Controller card connector.

When installing a SAS hard disk drive in the Z800, move the drive data cable from the system board SATA connector to a system board SAS connector.

See the workstation *Maintenance and Service Guide* for connector locations and installation details.

7. Replace all components that were removed in preparation for component installation.

10 Installing optical disk drives

This section describes how to install an optical disk drive (ODD) in the workstation.

Installing an ODD in an HP Z400 Workstation

This section describes how to install an optical disk drive in the HP Z400 Workstation in the mini-tower and desktop configurations.

Installing an optical drive (mini-tower configuration)

1. Follow the procedures described in [Preparing for component installation on page 43](#) to prepare the workstation for component installation.
2. If necessary, remove the blank filler and the EMI filler from the optical bay.
3. Install the four black metric M3 guide screws into the drive.

Figure 10-1 Installing the guide screws



4. Align the screws with the grooves in the drive bay and gently slide the drive into the casing while lifting the green drivelock release lever. When the drive is partially inserted, release the drivelock release lever and slide the drive completely into the bay until it snaps into place.

△ **CAUTION:** Verify that the optical disk drive is secure in the workstation chassis by pulling on the drive to see if it can be easily disengaged. Failure to properly secure the drive can damage the drive when moving the workstation.

5. Connect the power and data cables to the optical disk drive and system board as shown in the following figure. Refer to the side access panel service label for the location of the SATA connectors. Connect the data cable in the next available connector.

Figure 10-2 Connecting ODD power and data cables



6. Replace all components that were removed in preparation for component installation.

Installing an optical drive (desktop configuration)

1. Follow the procedures described in [Preparing for component installation on page 43](#) to prepare the workstation for component installation.
2. If necessary, remove the blank filler and the EMI filler from the optical bay.
3. Install the four black metric M3 guide screws into the drive (1).

Figure 10-3 Installing the optical drive



4. Align the screws with the grooves in the drive bay and gently slide the drive into the casing until it snaps into place (2).

△ **CAUTION:** Ensure that the optical drive is secure in the workstation chassis by pulling the drive to see if it can become disengaged. Failure to properly secure the drive can cause damage to the drive when moving the workstation.

5. Connect the power and drive cables to the drive and system board.

Installing an ODD in an HP Z600 or Z800 Workstation

To install an ODD:

1. Follow the procedures described in [Preparing for component installation on page 43](#) to prepare the workstation for component installation.
2. If necessary, lift the optical bay filler tray handle and remove it from the workstation.
3. Lift and hold the green optical drive bay release latch (1) while sliding the drive into the bay (2). When the front of the optical drive is near its final position, let go of the latch, but continue to slide the drive inward until the latch closes and engages the drive as shown below. (An HP Z600 Workstation is shown for example.)

💡 **TIP:** During installation the adjacent drive or filler may move slightly. It may be necessary to slide and align both devices to get the release latch to close and engage both devices.

⚠️ **CAUTION:** Verify that the optical drive is secure in the workstation chassis by pulling on the drive to see if it can be easily disengaged. Failure to properly secure the drive can damage the drive when moving the workstation.

Figure 10-4 Installing the optical drive



4. Connect the power and data cables to the optical disk drive as shown in the following figure. (An HP Z600 Workstation is shown for example.)

Figure 10-5 Connecting ODD power and data cables

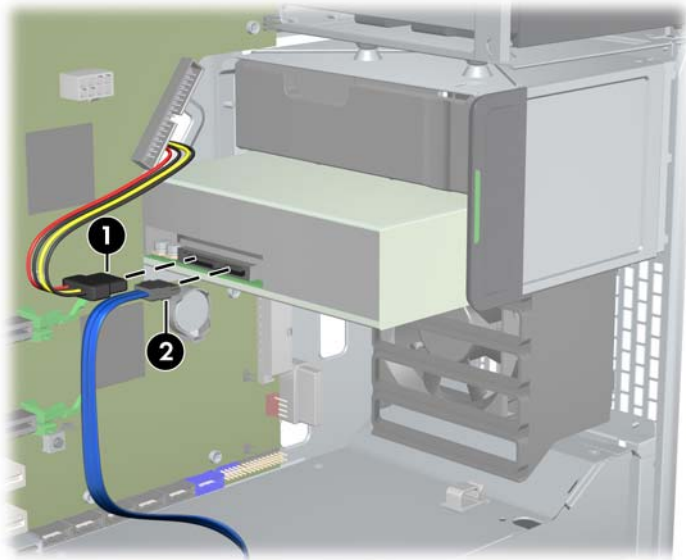

5. Connect the optical disk drive data cable to the appropriate and available SATA port on the system board as shown in the following figure (example shows HP Z600 Workstation).

NOTE: All HP Z800 Workstation optical disk drives should be connected to either SATA or SAS system board connectors. If there are not enough SATA connectors to accommodate all drives, then connect all drives to the SAS system board connectors. Refer to the workstation service label on the side access panel for SATA and SAS connector locations.

Figure 10-6 Connecting the ODD data cable to the system board

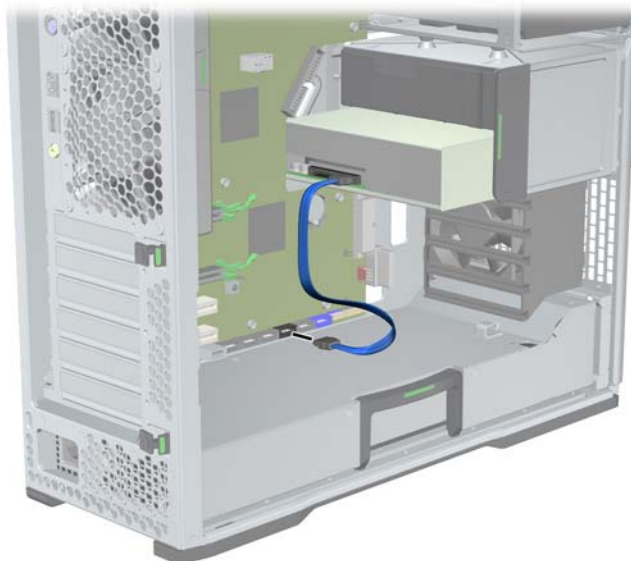

6. Replace all components that were removed in preparation for component installation.

Notice for Blu-ray optical drives

If you installed a Blu-ray optical drive, note the following:

Blu-ray movie playback

As Blu-ray is a new format containing new technologies, certain disc, digital connection, compatibility and/or performance issues may arise, and do not constitute defects in the product. Flawless playback on all systems is not guaranteed. In order for some Blu-ray titles to play, they may require a DVI or HDMI digital connection and your display may require HDCP support. HD-DVD movies cannot be played on this workstation.

Blu-ray movie playback compatibility and update

Playing back Blu-ray HDCP (High-bandwidth Digital Content Protection) content such as commercially distributed Blu-ray HD movies requires a fully HDCP compliant path on your computer. The HDCP technology checks compliance of each component in the path from the content on the Blu-ray disc all the way to the display monitor, including but not limited to graphic cards and monitor adapters.

The HP Z400, Z600 and Z800 Workstations have been designed with this in mind; nearly all configurations with currently available HP Professional Displays are compliant. Older HP xw4600 and xw9400 Workstation configurations may not have fully compliant paths based on the installed graphics card and display monitor; HP recommends confirming separately that you have a fully compliant system if commercial content playback is a requirement for your use. HDCP compatibility of your graphics card and monitor can be determined by checking the *QuickSpecs* at <http://www.hp.com/go/productbulletin>.

For the best HDCP performance, HP recommends that you install the latest updates:

1. Blu-ray player firmware
2. Playback application patches
3. Graphics firmware and drivers

Updates are located on the support web site for your specific product at <http://www.hp.com/support/workstations>.

Index

A

- Air flow guide
 - Removing 43

B

- BIOS
 - Determining version 35
 - Updating 36

D

- Drivers
 - Installing 32
 - Updating 32, 36

E

- Expansion card
 - Installing 53
 - Slot identification 53
- Expansion card support
 - Removing 43
- Expansion slot cover
 - Removing 43

F

- Front bezel
 - Removing 43

G

- Graphics cards
 - Types 26

H

- Hard drive
 - Configuration 55
 - Installing 55
- Hardware
 - Disassembly 43
- HP Backup and Recovery 40
- HP resources
 - Locating 1
 - Product diagnostics 5
 - Product documentation 4
 - Product information 2
 - Product support 3

- Product updates 6
- Web links 4

I

- Installing
 - Expansion cards 53
 - Hard drive 55
 - hardware 43
 - Memory 48
 - Optical drive 61
 - PCI/PCIe cards 53
- Installing memory 47

M

- Memory
 - Installation 48
- Memory fan
 - Removing 43
- Microsoft Windows
 - Setting up 32
 - Transferring files 32
- Monitors
 - Adjusting display 30
 - Configuring 29
 - Connecting 29
 - Graphics cards 26

N

- Novell SLED
 - Restoring 41
 - Setting up 34

O

- Operating system setup
 - Microsoft Windows 32
 - Red Hat Linux 33
- Operating system setup; Novell SLED 34
- Optical drive
 - Installing 61

R

- Red Hat Linux
 - Setting up 33

- RestorePlus! 38
- Restoring the operating system
 - Restore methods 37
 - Windows Vista 38
 - Windows XP 39

S

- Side access panel
 - Removing 43
- Software
 - Ordering 38
- Support
 - Locating HP resources 1
- System fan
 - Removing 43

U

- Updating the workstation
 - First boot update 34
 - Updating drivers 36
 - Updating the BIOS 36

W

- Windows Vista
 - Restoring 38
 - Setting up 32
- Windows XP
 - Restoring 39
 - Setting up 32
- Workstation
 - Preparing for component installation 43
- Workstation components
 - HP Z400 Workstation 7
 - HP Z400 Workstation chassis 8
 - HP Z400 Workstation front panel 9
 - HP Z400 Workstation rear panel 10
 - HP Z600 Workstation 11
 - HP Z600 Workstation chassis 12

HP Z600 Workstation front panel	13
HP Z600 Workstation rear panel	14
HP Z800 Workstation	15
HP Z800 Workstation chassis	16
HP Z800 Workstation front panel	17
HP Z800 Workstation rear panel	18
Workstation setup	
Accessibility	30
Connecting monitors	24
Customizing the display	30
Ensuring proper ventilation	19
Security	30
Setup procedures	20